

QUARTZITE DESIGN PROJECT

PORCELAIN PERFORMANCE DATA

COLORED BODY PORCELAIN PAVERS - Rectified Monocaliber

PHYSICAL PROPERTIES	TEST ASTM	NORTH AMERICAN STANDARD A137.3*	RESULTS
Water absorption *	C373	≤ 0.5%	COMPLY WITH ANSI A137.3
DCOF Average dynamic coefficient of friction **	ANSI A.326.3	As reported	EW - Exterior, Wet
Skid Resistance	EN 16165 (EX DIN 51097) EN 16165 (EX DIN 51130)	-	A+B+C R11
Resistance to freeze/thaw cycling *	C1026	As reported	RESISTANT
Resistance to thermal shock	C484	As reported	RESISTANT
Warpage (edge)	C485	Warpage ± 0.4% or ± 0.05 in	COMPLY WITH ANSI A137.3
Warpage (diagonal)	C485	Warpage ± 0.4% or ± 0.07 in	COMPLY WITH ANSI A137.3
Wedging	C502	± 0.25% or ± 0.03 in	COMPLY WITH ANSI A137.3
Chemical resistance	C650	As reported	UNAFFECTED
Resistance to stain	C1378	As reported	UNAFFECTED
Thickness	C499	Range: 0.04 in	COMPLY WITH ANSI A137.3
Breaking strength	C1505	2000 lbf	COMPLY WITH ANSI A137.3
Module of Rupture	C1505	5000 psi	COMPLY WITH ANSI A137.3

* Average values referred to our production and related to the matt finish of the product.
 ** As far as values relating to the matt finish of the product and to tests carried out by certified external laboratories whose results are available upon request at Headoffice, we are willing to check the lot you are interested in purchasing.
 - Be sure to use pavers belonging to the same caliber.
 - Test results are available on request.
 - The information provided can be subject to change. Please refer to outdoor.landmarkceramics.com for the latest, most accurate and up-to-date information.

For further details about product in 20mm thickness and in particular for recommendations, instructions and restrictions of use and installation, please refer to the Frontier20 catalog or visit the website outdoor.landmarkceramics.com



LEARN MORE ABOUT



QUARTZITE DESIGN PROJECT

TRIM PIECES

COLORED BODY PORCELAIN PAVERS - Rectified Monocaliber

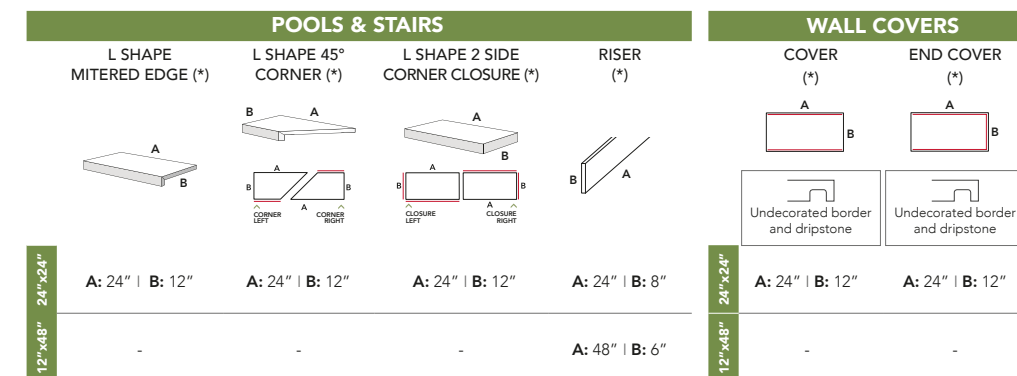
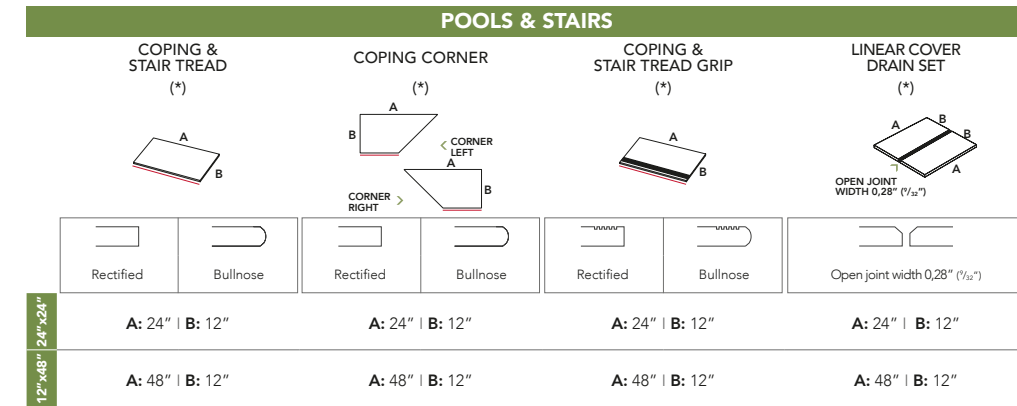

(*) Available in standard version (with undecorated borders).



QUARTZITE DESIGN PROJECT

TRIM PIECES

COLORED BODY PORCELAIN PAVERS - Rectified Monocaliber

M.P.D. BIG

<p>M.P.D. BIG ONE*</p> <p>Module % 24"x48" = 40% 24"x24" = 20% MIX = 40% **</p>	<p>M.P.D. BIG FIVE*</p> <p>Module % 24"x48" = 58% 12"x48" = 14% 24"x24" = 14% 12"x24" = 7% 12"x12" = 7%</p>	<p>M.P.D. BIG NINE*</p> <p>Module % 24"x48" = 58% 12"x48" = 14% 24"x24" = 14% 12"x24" = 7% 12"x12" = 7%</p>	<p>M.P.D. BIG THIRTEEN*</p> <p>Module % 24"x48" = 62% 12"x48" = 30% 24"x24" = 17% 12"x24" = 8% 12"x12" = 8%</p>	<p>M.P.D. BIG SEVENTEEN*</p> <p>Module % 24"x48" = 33.5% 12"x48" = 33.5% 24"x24" = 17% 12"x24" = 8% 12"x12" = 8%</p>
<p>M.P.D. BIG TWO*</p> <p>Module % 24"x48" = 50% MIX = 50% **</p>	<p>M.P.D. BIG SIX*</p> <p>Module % 24"x48" = 45% 12"x12" = 11% MIX = 44% **</p>	<p>M.P.D. BIG TEN*</p> <p>Module % 24"x48" = 58% 12"x48" = 14% 24"x24" = 14% 12"x24" = 14%</p>	<p>M.P.D. BIG FOURTEEN*</p> <p>Module % 24"x48" = 67% 12"x48" = 33%</p>	<p>M.P.D. BIG EIGHTEEN*</p> <p>Module % 24"x48" = 50% 12"x48" = 50%</p>
<p>M.P.D. BIG THREE*</p> <p>Module % 24"x48" = 40% 24"x24" = 20% MIX = 40% **</p>	<p>M.P.D. BIG SEVEN*</p> <p>Module % 24"x24" = 31% 12"x12" = 8% MIX = 61% **</p>	<p>M.P.D. BIG ELEVEN*</p> <p>Module % 24"x48" = 31% 12"x48" = 15% 24"x24" = 31% 12"x24" = 15% 12"x12" = 8%</p>	<p>M.P.D. BIG FIFTEEN*</p> <p>Module % 24"x48" = 38% 12"x48" = 19% 24"x24" = 19% 12"x24" = 19% 12"x12" = 5%</p>	<p>M.P.D. BIG NINETEEN*</p> <p>Module % 24"x48" = 38% 24"x24" = 19% 12"x12" = 5% MIX = 36% **</p>
<p>M.P.D. BIG FOUR*</p> <p>Module % 24"x48" = 28.6% 24"x24" = 14.3% MIX = 57.1% **</p>	<p>M.P.D. BIG EIGHT*</p> <p>Module % 24"x48" = 31% 12"x48" = 45% 24"x24" = 23% 12"x24" = 11%</p>	<p>M.P.D. BIG TWELVE*</p> <p>Module % 24"x48" = 22% 12"x48" = 45% 24"x24" = 22% 12"x24" = 11%</p>	<p>M.P.D. BIG SIXTEEN*</p> <p>Module % 24"x48" = 38% 12"x48" = 19% 24"x24" = 19% 12"x24" = 19% 12"x12" = 5%</p>	<p>M.P.D. BIG TWENTY*</p> <p>Module % 24"x48" = 18% 12"x12" = 4% MIX = 78% **</p>

M.P.D. SMALL

<p>M.P.D. SMALL ONE*</p> <p>Module % 24"x24" = 67% 12"x12" = 33%</p>	<p>M.P.D. SMALL FIVE*</p> <p>Module % 24"x24" = 57% 12"x24" = 29% 12"x12" = 14%</p>	<p>M.P.D. SMALL NINE*</p> <p>Module % 24"x24" = 50% 12"x24" = 25% 12"x12" = 25%</p>
<p>M.P.D. SMALL TWO*</p> <p>Module % 12"x24" = 80% 12"x12" = 20%</p>	<p>M.P.D. SMALL SIX*</p> <p>Module % 24"x24" = 33% 12"x24" = 50% 12"x12" = 17%</p>	<p>M.P.D. SMALL TEN*</p> <p>Module % 12"x24" = 75% 12"x12" = 25%</p>
<p>M.P.D. SMALL THREE*</p> <p>Module % 24"x24" = 50% 12"x24" = 50%</p>	<p>M.P.D. SMALL SEVEN*</p> <p>Module % 24"x24" = 57% 12"x24" = 29% 12"x12" = 14%</p>	<p>M.P.D. SMALL FOUR*</p> <p>Module % 24"x24" = 67% 12"x24" = 33%</p>
<p>M.P.D. SMALL EIGHT*</p> <p>Module % 24"x24" = 44% 12"x24" = 45% 12"x12" = 11%</p>		

* Modular products with 6 mm joint (approx 1/4").
 ** NOTE: The 24"x36" and 12"x24" sizes (MIX) are palletized together on the same single pallet containing the correct percentages of each size.



- Available colors
- Arctic White
 - African Beige
 - Star Grey



QUARTZITE DESIGN PROJECT

QUARTZITE DESIGN PROJECT

COLORED BODY PORCELAIN PAVERS - Rectified Monocaliber

A TRIBUTE TO ONE OF THE MOST AUTHENTIC AND ICONIC STONES.

QDP, Quartzite Design Project, represents our tribute to the **Quartzite natural stone**. A stone deeply and widely used in architecture and now reinterpreted and proposed in **porcelain**, for **360° application** whether in **residential or commercial areas**, for both **indoor and outdoor**, and for **floors and walls**.

With its **contemporary interpretation** of the **granular texture** of the quartzite stone, **Quartzite Design Project** is ideal for **outdoor spaces** thanks to the **Porcelain Pavers, Porcelain Veneers** and **Porcelain Grip Tiles** offering.

THE QUARTZITE WORLD IN YOUR HAND.

Quartzite Design Project offers **endless possibilities** to every project, thanks to its **broad selection of surfaces, sizes and thicknesses**.

The project is **composed and designed** to fit **every surface with unquestionable appeal**, and embraces **4 different product categories**:



But **exterior** is not the only possible application. In fact, **QDP** is perfect for **indoor or In&Out transitional applications** too, thanks to the **Porcelain Tiles** offering, belonging to our **Explore collection** and available in **9mm thickness**.

Quartzite Design Project is a **stone effect** with a **strong character** and **chromatic richness** that celebrates all the beauty of this **superior natural look architectural stone**.

Porcelain Pavers: 3 colors, available in **20mm thickness** within **Frontier20 range**, ideal for **360° outdoor applications** with **outstanding technical performances** and a **wide size offering** from **12"x12"** to **24"x48"**.

Porcelain Veneers: 4 color proposal to decorate **every wall both indoor or outdoor** with the same **authentic and rich look** of the best **natural quartzite stones**, by blending the **tradition of the veneers**, a modern **Urban Ledgestone shape** and the **remarkable performance of porcelain**.

Porcelain Grip Tiles: 4 colors offered in **9mm thickness** that fits **every outdoor installation over concrete** or **indoor application**, wherever an **outstanding slip resistance** is needed.

Porcelain Tiles: 5 colors in 9mm, ranging from **12"x24"** to **24"x48"** size, to **complete your project** by transitioning the same **quartzite look** either on **every outdoor or indoor wall** no matter in **commercial or residential applications**, for both **floor and wall**.

FRONTIER20

PORCELAIN PAVERS - 20mm thickness

COLORED BODY PORCELAIN PAVERS - Rectified Monocaliber

ARCTIC WHITE

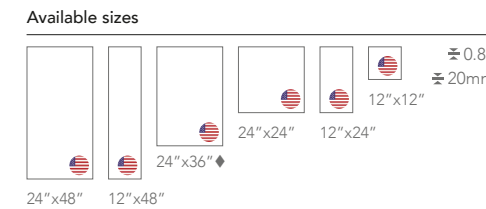

STAR GREY

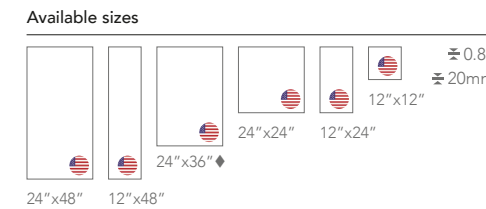

◆ NOTE: 24"x36" is sold as mix (24"x36" + 12"x24") along with 12"x24". The two sizes are palletized on the same pallet and sold together.

AFRICAN BEIGE

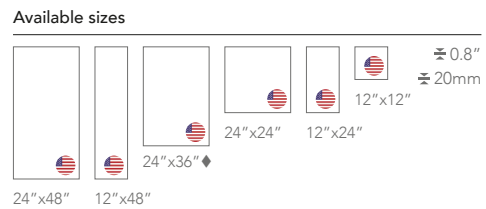

VENEER

WORLD

COLORED BODY PORCELAIN VENEERS - Rectified Monocaliber



ARCTIC WHITE

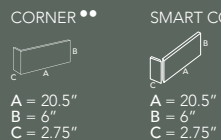

AFRICAN BEIGE

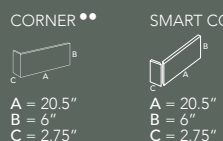

STAR GREY

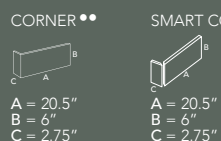

- Nominal Size: 5.8"x24"
- Nominal Size: 20.5"x5.8"x2.75"



VOLCANIC BLACK

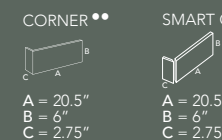
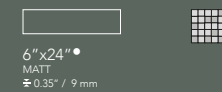

Color Shading

- V1 UNIFORM APPEARANCE
- V2 SLIGHT VARIATION
- V3 MODERATE VARIATION
- V4 SUBSTANTIAL VARIATION

URBAN LEDGESTONE

GRIP TILES

PORCELAIN GRIP TILES - 9mm thickness

COLORED BODY PORCELAIN GRIP TILES - Rectified Monocaliber

EXPLORE ARCTIC WHITE GRIP



EXPLORE STAR GREY GRIP



EXPLORE AFRICAN BEIGE GRIP



EXPLORE EVEREST DARK GRIP



The color of tiles printed in this catalog may differ from actual tiles. Tile color reproductions in this catalog are representative only. Slight tone and shade variations are inherent in porcelain tiles. Before selecting a color, we recommend that you contact your local representative, who will provide you with a sample piece of the requested tile. This porcelain tile product is manufactured with a V2 shade variation. Remember that the amount of color as well as the texture of each piece may vary from tile to tile. Inspect the product immediately upon delivery and select tiles from many boxes during installation to minimize and blend any possible color difference.

COORDINATED PORCELAIN TILES

FOR IN&OUT APPLICATIONS AND OUTDOOR WALLS

	Explore Arctic White	Explore African Beige	Explore Star Grey	Explore Everest Dark	Explore Volcanic Black
24"x48" MATT ±0.35" / 9mm	•	•	•	•	•
24"x24" MATT ±0.35"	•	•	•	•	•
12"x24" MATT ±0.35"	•	•	•	•	•
12"x12" MOSAIC A ±0.35"	•	•	•	•	•
12"x10" MOSAIC D ±0.35"	•	•	•	•	•
3"x24" BULLNOSE	•	•	•	•	•
6"x12" COVE BASE	Vision Color Star White	Vision Dove	Vision Concrete	Vision Concrete	Vision Concrete

